

The Aspire LED downlight range is a high quality, low glare fixed downlight incorporating 3-Step Macadam Ellipse Cree CXA LEDs for best-in-class performance. High quality cold-forged 1060 aluminium heat sink for optimal thermal management and long life. Interchangeable reflectors offering different beam angles and glare ratings. Flicker free, 2-Stage Driver Technology for reliability in all applications. Product Features.



- **Electrical Parameters**

Power: 6W - 80W
 Input Voltage: 220-240V 50/60Hz
 Power Factor: 0.95, Flicker Free
 IP Rating: IP40 (Optional IP56 and IP65)
 Dimmable: Phase Cut, 1-10v, Dali
 Fitted with 1.5m Flex & Plug
 Certificates: CE, ROHS, SAA
 Standards: EN 55015:2006+A1:2007+A2:2009 /
 EN 61000-3-2:2006+A1:2009+A2:2009 /
 EN 61000-3-3:2008/EN 61547:2009

- **Photometric Parameters**

CRI: ≥80 ≥90 Ra
 Beam Angle: 15° , 24° , 40° , 60° , Opal Diffused
 Colour Temperatures: 3000k / 4000k / 5000k

- **High lumen is achieved using Cree CXA 2540**



- **Lifetime**

Lifetime (F50): 50,000 hrs
 Lumen maintenance (L70): 50,000hrs
 Min/Max operating Temp: -20°C /+40°C
 Warranty: 5 years

- General Information**

Fascia Material: Die-cast 6063 Aluminium

Heatsink Material: Cold forged 1060 Aluminium

Reflector: Aluminium Faceted Reflector

Lens: Clear glass or opal diffuser

AC Power Wire: H03VV-F 3*0.75mm²

DC Power Wire: H03VV-F 2*0.5mm²

Product Colour: White Trim (Other trim colour options on request)



- Product Dimensions**

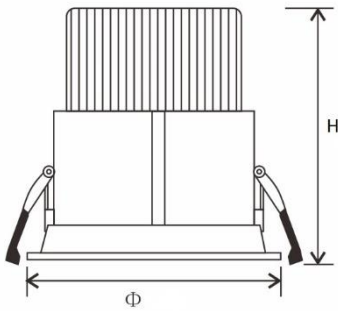

Watt	Φ/mm	H/mm	Cutout/mm
6-9w	Φ 95	102	75
9.5-14w	Φ 115	116	95
20-30w	Φ 160	133	140
35-50w	Φ 160	153	140
35-55w	Φ 185	136	160



● Order Codes

Change code to suit required specification:

- Beam Angle **xx** – Beam Angle (15° / 24° / 45° / 60° / Op)
- Optional IP rating, add suffix: **IP56 / 65**
- Dimmable Suffix **-D** (Triac), **-10V** (1-10V), **-Dali** (Dali)
- Example: “DL-CXA115-14W-4K-60-IP65-DALI”

95mm diameter Aspire, 75mm cut out (102mm H)

Alpha Code	Watts	Colour Temp.	Lumen Output	Product Weight	Outer Packing Dimensions
EL-ASPIRE-CXA95-5W-3K-36	5W	3000k	460 lm	0.19kg	480*480*470mm 64pcs/ctn
EL-ASPIRE-CXA95-5W-4K-36	5W	4000k	475 lm		
EL-ASPIRE-CXA95-8W-3K-36	8W	3000k	816 lm	0.19kg	480*480*470mm 64pcs/ctn
EL-ASPIRE-CXA95-8W-4K-36	8W	4000k	842 lm		

115mm diameter Aspire, 95mm cut out (116mm H)

Alpha Code	Watts	Colour Temp.	Lumen Output	Product Weight	Outer Packing Dimensions
EL-ASPIRE-CXA115-9W-3K-xx	9.5W	3000k	878 lm	0.35kg	480*480*470mm 48pcs/ctn
EL-ASPIRE-CXA115-9W-4K-xx	9.5W	4000k	905 lm		
EL-ASPIRE-CXA115-15W-3K-xx	15W	3000k	1558 lm	0.35kg	480*480*470mm 48pcs/ctn
EL-ASPIRE-CXA115-15W-4K-xx	15W	4000k	1,606 lm		

160mm diameter Aspire, 140mm cut out (133mm H)

Alpha Code	Watts	Colour Temp.	Lumen Output	Product Weight	Outer Packing Dimensions
EL-ASPIRE-CXA160-20W-3K-xx	20W	3000k	2,077 lm	0.77kg	525*390*495mm 18pcs/ctn
EL-ASPIRE-CXA160-20W-4K-xx	20W	4000k	2,141 lm		
EL-ASPIRE-CXA160-25W-3K-xx	25W	3000k	2,596 lm	0.77kg	525*390*495mm 18pcs/ctn
EL-ASPIRE-CXA160-25W-4K-xx	25W	4000k	2,676 lm		
EL-ASPIRE-CXA160-30W-3K-xx	30W	3000k	3,115 lm	0.77kg	525*390*495mm 18pcs/ctn
EL-ASPIRE-CXA160-30W-4K-xx	30W	4000k	3,212 lm		

160mm diameter Aspire, 140mm cut out (153mm H)

Alpha Code	Watts	Colour Temp.	Lumen Output	Product Weight	Outer Packing Dimensions
EL-ASPIRE-CXA160T-40W-3K-xx	40W	3000k	4,153 lm	0.86kg	525*390*495mm 18pcs/ctn
EL-ASPIRE -CXA160T-40W-4K-xx	40W	4000k	4,282 lm		
EL-ASPIRE -CXA160T-45W-3K-xx	45W	3000k	4,673 lm	0.86kg	525*390*495mm 18pcs/ctn
EL-ASPIRE -CXA160T-45W-4K-xx	45W	4000k	4,818 lm		
EL-ASPIRE -CXA160T-50W-3K-xx	50W	3000k	5,095 lm	0.86kg	525*390*495mm 18pcs/ctn
EL-ASPIRE -CXA160T-50W-4K-xx	50W	4000k	5,253 lm		

185mm diameter Aspire, 160mm cut out (136mm H)

Alpha Code	Watts	Colour Temp.	Lumen Output	Product Weight	Outer Packing Dimensions
EL-ASPIRE -CXA185-40W-3K-xx	40W	3000k	4,153 lm	1.2kg	525*350*350mm 12pcs/ctn
EL-ASPIRE -CXA185-40W-4K-xx	40W	4000k	4,282 lm		
EL-ASPIRE -CXA185-45W-3K-xx	45W	3000k	4,673 lm	1.2kg	525*350*350mm 12pcs/ctn
EL-ASPIRE -CXA185-45W-4K-xx	45W	4000k	4,818 lm		
EL-ASPIRE -CXA185-50W-3K-xx	50W	3000k	5,095 lm	1.2kg	525*350*350mm 12pcs/ctn
EL-ASPIRE -CXA185-50W-4K-xx	50W	4000k	5,253 lm		

230mm diameter Aspire, 200mm cut out (176mm H)

Alpha Code	Watts	Colour Temp.	Lumen Output	Product Weight	Outer Packing Dimensions
EL-ASPIRE -CXA230-60W-3K-xx	60W	3000k	5,886 lm	1.7kg	650*410*430mm 18pcs/ctn
EL-ASPIRE -CXA230-60W-4K-xx	60W	4000k	6,068 lm		
EL-ASPIRE -CXA230-70W-3K-xx	70W	3000k	6,866 lm	1.7kg	650*410*430mm 18pcs/ctn
EL-ASPIRE-CXA230-70W-4K-xx	70W	4000k	7,079 lm		

285mm diameter Aspire, 255mm cut out (210mm H)

Alpha Code	Watts	Colour Temp.	Lumen Output	Product Weight	Outer Packing Dimensions
ASPIRE-CXA285-80W-3K-xx	80W	3000k	7,847 lm	1.87kg	735*485*410mm 12pcs/ctn
ASPIRE -CXA285-80W-4K-xx	80W	4000k	8,090 lm		

● **Luminous Intensity Distribution (DL-CXA160T-30W-3K-60)**

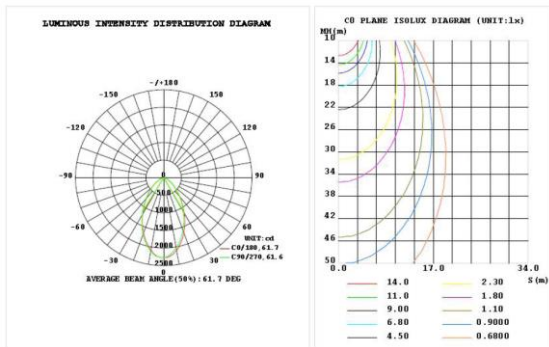

Spectroradiometric Parameters

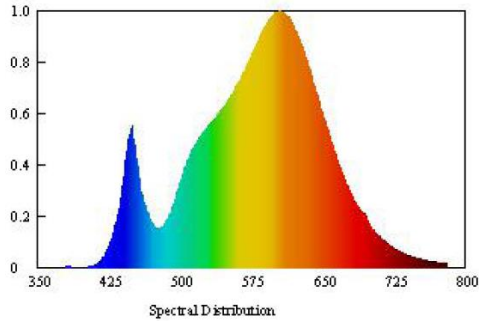

(DL-CXA185-45W-3K-60)

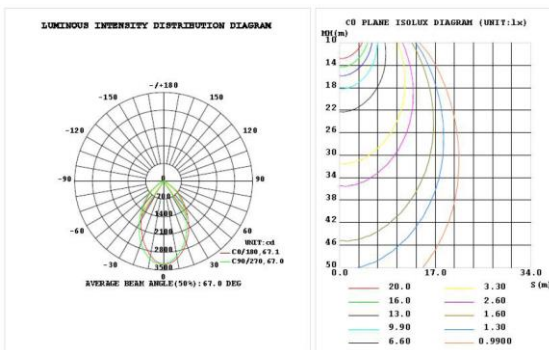

Spectroradiometric Parameters

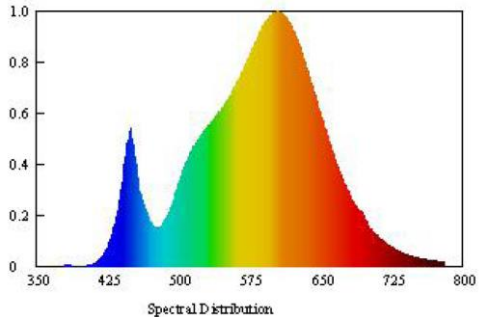

(DL-CXA160T-30W-4K-60)

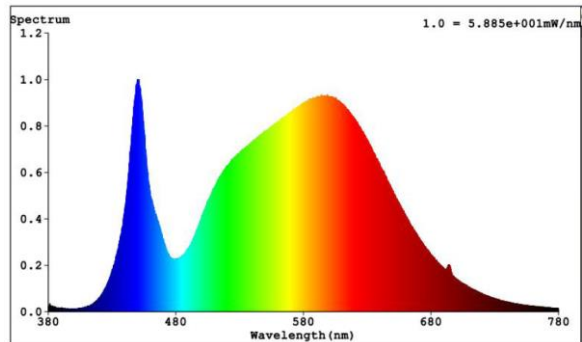
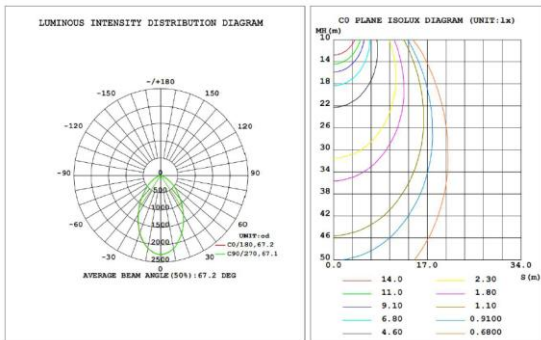

(DL-CXA285-60W-4K-60)

